

ITEM	PART NO.	DESCRIPTION	QTY.
1	302507-11	HOUSING FRONT MAG DRIVE BOLT ON STYLE	0.677
2	350522-20	6005 25 X 47 X 12 BALL BRG DBL SEAL	2
3	302507-10	SIDE FLANGE DRIVEN FRONT MAG DRIVE	2
4	351550-24	024 "O" RING .070 X 1.125	2
5	302507-12	HOUSING CAP FRONT MAG DRIVE	1
6	302521-07	GEAR DRIVER W-SPLINE 90 DEG MAG DRIVE	1
7	359950-03	-3 AN PLUG	2
8	302521-41	GEAR DRIVEN 13T RH 32.5 HELIX 14.15DP	1
9	302507-15	OUTPUT SHAFT MAG DRIVE 90 DEGREE SPLINE W-SEAL	1
10	352504-04	WASHER 0.2 THK 0.98 DIA W-C-BORE	1
11	302507-13	HOUSING EXTENSION FOR MSD 44	1
12	302526-60	BUSHING BRONZE MC-7815K29	1
13	350522-13	20 X 32 X 7 BALL BRG DBL SEAL	1
14	301830-02	COUPLER HALF MSD MAGNETO	1
15	355431-10	5/16-24 NUT HEX FLANGED LOCK	1
16	352503-05	5/16 AN WASHER	1
17	351505-21	0.875 X 1.125 X 0.125 SEAL NEOPRENE 1 LIP	1
18	351550-34	034 "O" RING 0.70 X 2.125	2
19	357308-08	SHCS 8-32 x .50	6

ITEM	PART NO.	DESCRIPTION	QTY.
20	357625-08	HHB 1/4-28 x .50	1
21	357308-06	SHCS 8-32 x .375	16
22	356808-10	FHCS 8-32 X 0.625	3
23	302507-14	COUPLER HALF ROTEX SPLINED w-magnet pocket	1
24	351550-35	035 "O" RING .07 x 2.25	2
25	354910-25	ROTEX SPYDER #24 GREEN	1
26	353533-16	3/16 x 1.00 SPRING PIN SLOTTED	1
27	352503-06	3/8 AN WASHER	1
28	302521-09	SLEEVE FOR SPLINED INPUT SHAFT	1
29	302506-01	RING SIDE FLANGE CHANGE	1
30	302526-45	SEAL RETAINER FRONT MAG DRIVE	1
31	351505-27	SEAL 1.000 X 1.25 X 0.125 NEOPRENE 1 LIP	1
32	351550-24	024 "O" RING .070 X 1.125	1
33	351005-185	SNAP RING INT 1.85 HOUSING x .062	2
34	351010-66	SNAP RING EXT .669 SHAFT	1
35	302521-32	INPUT SHAFT FRONT MAG DRIVE 90 DEG SPLINE .50 HEX	1
36	351005-118	SNAP RING INT 1.188 HOUSING x .05	1

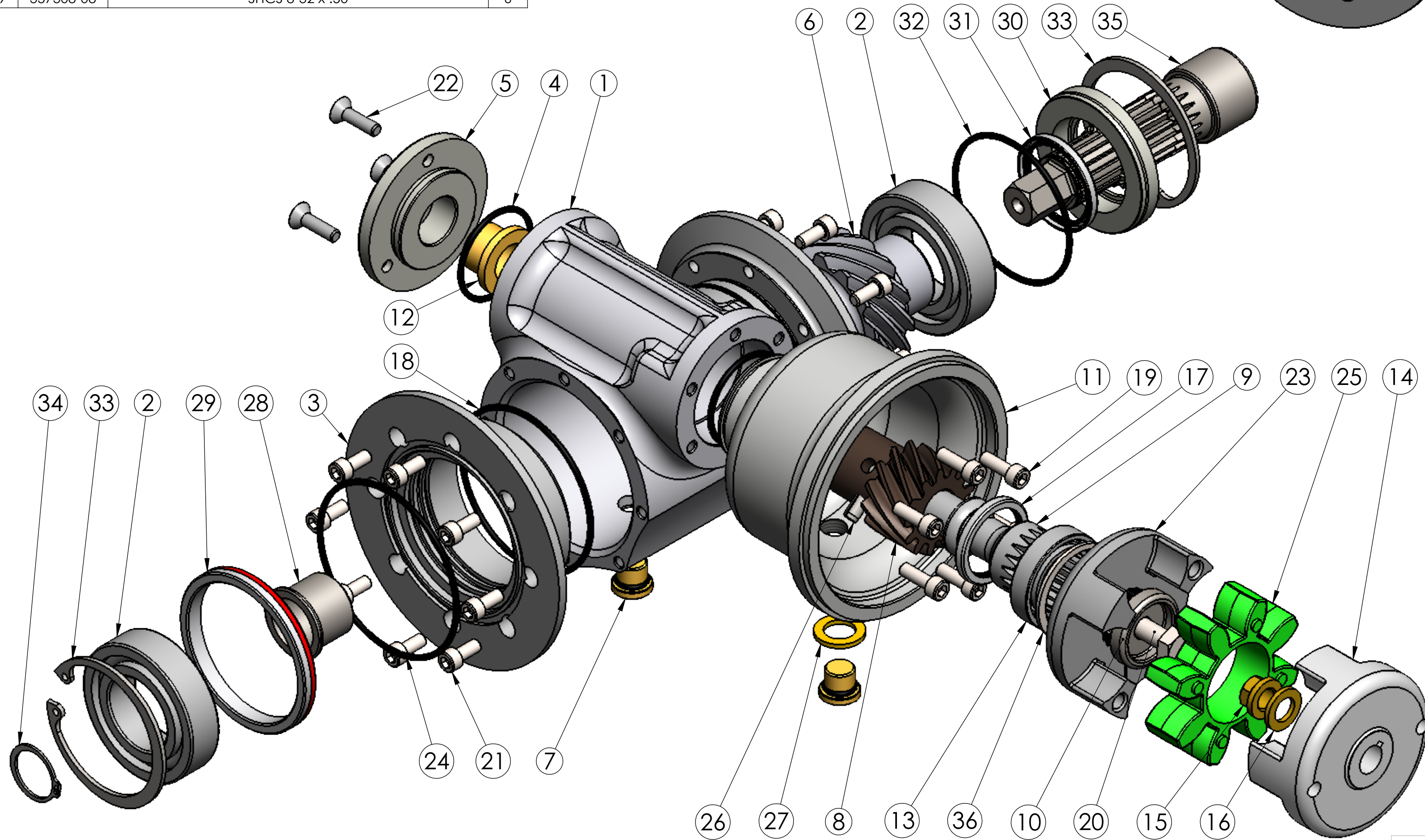
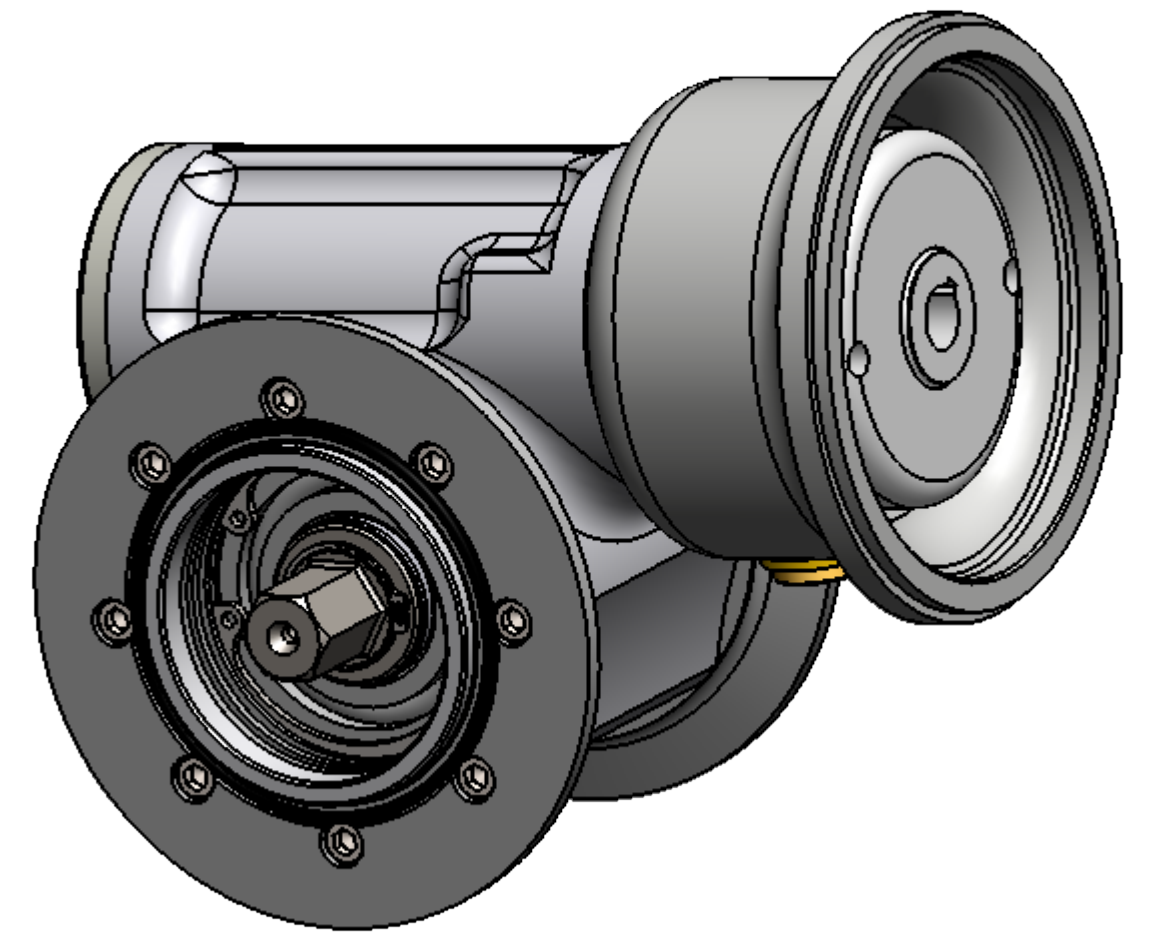

FRONT MAGNETO DRIVE CCW ROTATION .50 HEX